



# **SIDE WALL VENTING SYSTEMS**

**for oil and gas heating equipment**



*Affordable, easy to install and reliable.  
Features Stainless Steel construction for all critical parts.*

*Compare These*

# Side Wall Venting Means

- **No Chimney/Chase**
- **More Living Space**
- **Increased Safety & Efficiency**
- **Lower Installation Costs**

Venting for heating appliances doesn't have to go through the roof, either does the cost. In more than one million installations, Tjernlund side wall vent systems have proven superior to other venting alternatives in performance and safety. What's more, they substantially reduce heating installation costs.

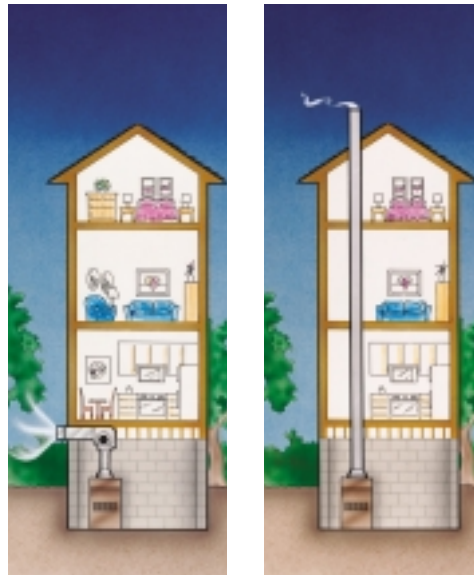

## Eliminates Chimney

Save costly installation or repair of chase and chimney by side wall venting. Also, eliminating chase increases living space and affords greater interior layout flexibility.

## Easy, One-Person Installation

There's no pre-installation assembly required. Units attach to all classes of standard vent pipe. To reduce weight during installation and maximize serviceability, mechanical and electrical assemblies are located on the back of the unit and attached after vent termination is installed.



Cut Opening



Install Vent Termination



Install Venter Assembly

## Featuring UC1 Burner Interlock Control

- Simplifies new installations and service calls since operation and wiring interlock problems are diagnosed and displayed through LED indicators.
- Adjustable pre/post purge.
- Prover switch delay eliminates burner start up or wind induced prover switch short cycling.
- Interlock voltage can be selected, (24 or 115 VAC), eliminating false triggering by burner monitoring circuits.
- Add MAC1E controller to interlock 1 additional heater.



## Zero Clearance

SideShot vent systems may be installed with zero clearance to combustibles. This feature expands location opportunities including installation between floor joists for above-grade termination.

# Practical Features

## Patented High Velocity Exhaust

All gases and soot are propelled by jet action from the the exhaust hood to prevent staining of the building exterior.

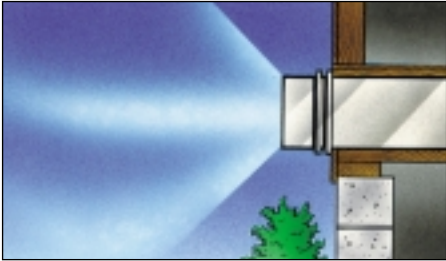

## Unsurpassed Safety

Tjernlund Venter controls make side wall venting safer than a chimney. 3-way protection includes:

**UC1 Control** — Interlocks with burner and monitors vent system safeties.

**Pressure Switch** — Monitors draft and detects outlet blockages.

**High Limit** — Interrupts burner if the unit casing exceeds safe temperatures.

## Quiet Operation

Side wall systems do not touch joists or subfloor. Special vibration absorbing wall-mounting bracket reduces operating noise to a minimum.

## Energy Efficient

A moderate, regulated on-cycle draft is created for optimum burner efficiency and blocks heat loss to outdoors during off-cycle periods. Chimneys notorious for heat loss are eliminated.

## Weather Protected Operating Components

All mechanical and electrical parts are easily accessible from inside, where they belong, away from potentially damaging cold and wet weather.

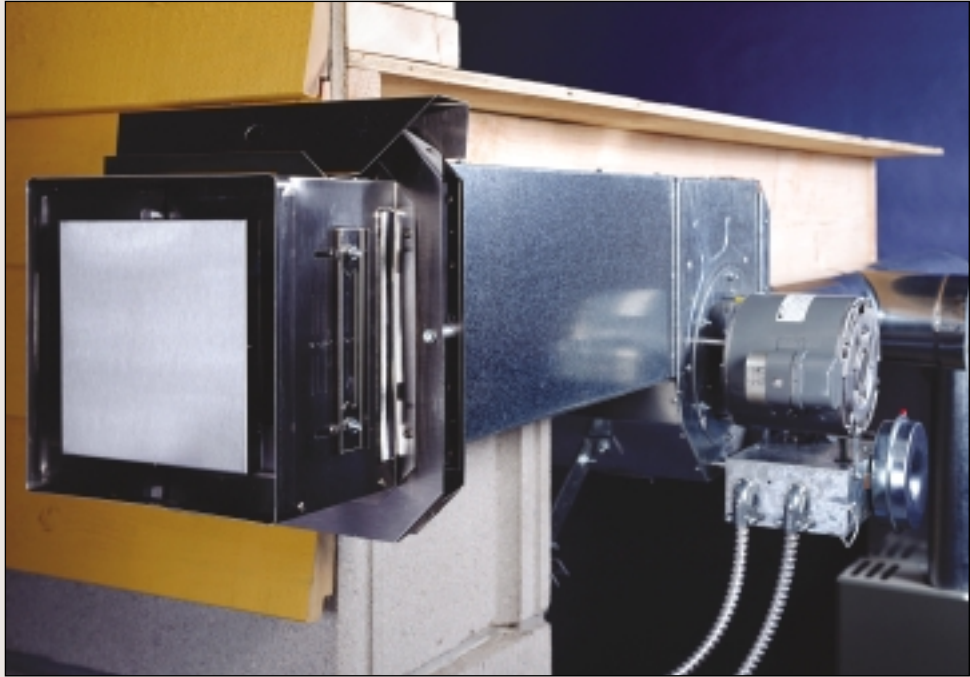

The SideShot 1 was developed and introduced by Tjernlund in 1990 and revolutionized the way many heating systems were vented. Today, the SS1 is still a popular choice for larger burners and venting of multiple heaters.

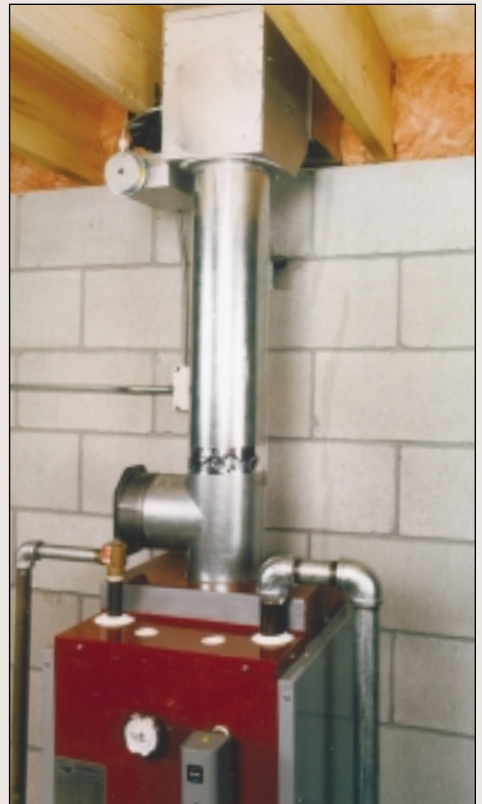

# Deluxe Side Wall Vent Systems for Higher Firing Rates

Look Inside — see how the SideShot is changing the direction of natural draft heating equipment

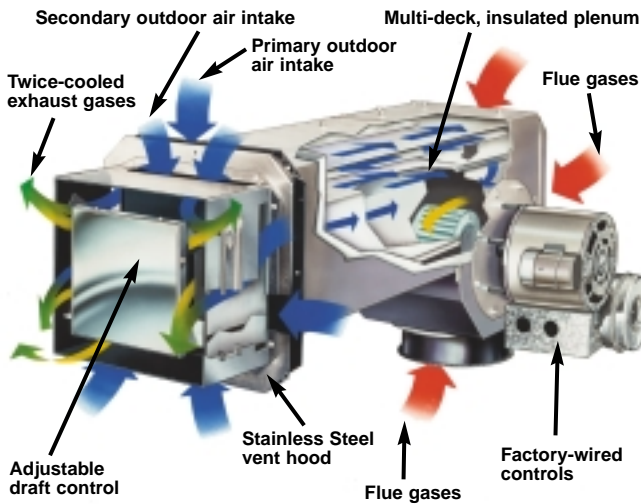

## General Description

The SideShot 1 is intended for use with natural draft oil and gas heating equipment. It automatically vents the flue gases from heating equipment to the outdoors. Surrounding combustible surfaces and exhaust gases are kept at safe temperatures by pulling outdoor air into its casing and mixing it with the flue gases during operation. After each burner cycle the SS1 will continue to operate for an adjustable period to purge the heater and vent of residual gases.

The SS1 features a 3-way safety system consisting of the UC1 Interlock Control, Fan Proving Switch and High Limit. These devices monitor the SS1 performance and will disrupt the burner if a vent system malfunction is detected.

## Electrical

### Typical Burner Interlock with Aquastat

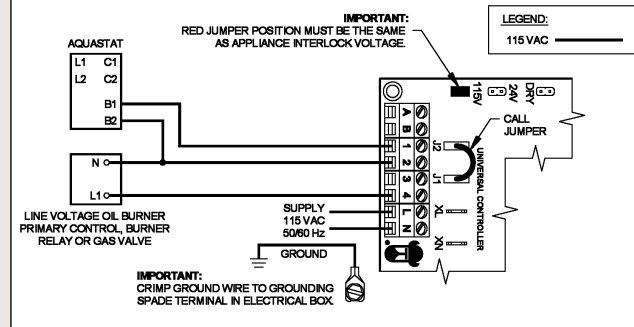

## SideShot 1 Application Tables

Verify that the total BTU/hr. input of the heating appliance(s) fall within the proper category listed below. Please note the maximum equivalent feet and capacity differs between the SS1 and SS1C. To determine equivalent feet, add the total length of straight vent pipe plus 10 feet for each 90 degree elbow and 5 feet for each 45 degree elbow. Vent runs of over 15 linear feet should use an approved, insulated vent connector to prevent problems related to sulfur condensation.

Note: The SS1 features a bottom or rear vent connection. The inlet collar accepts any brand or type of 6" diameter vent pipe.



MODEL	Natural LP Gas	Flame Retention Oil Burner	Standard Oil Burner	Max. Equivalent Feet
SS1	50,000 - 160,000 BTU/hr.	70,000 - 220,000* BTU/hr.	70,000 - 180,000* BTU/hr	50

SS1C For Capacities Up To 315,000 BTU/hr.



MODEL	Natural LP Gas	Flame Retention Oil Burner	Standard Oil Burner	Max. Equivalent Feet
SS1C	NA	50,000 - 315,000* BTU/hr.	50,000 - 223,000* BTU/hr	50

\*Calculate BTU/hr. input based on nozzle size and actual pump pressure.

## Dimensions

A	B	C	D	E	F	G	H	I
27-3/8"	16-1/2"	12-1/4"	8"	13-3/4"	15-1/8"	7-3/4"	14-3/4"	23-1/4"

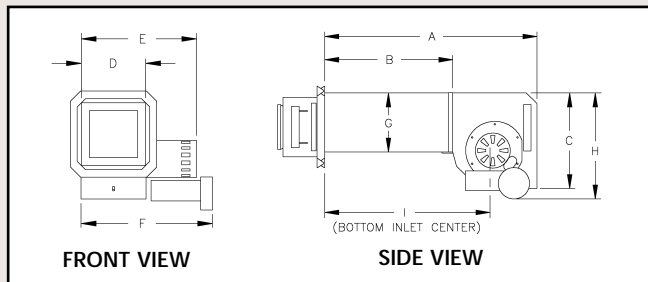

Note: The SS1 requires an 8"H x 8 3/8"W opening through the wall.



# Whisper quiet, 2nd generation vent system



## Indoor Draft Adjustment

Precise draft is achieved by simply turning knob located on back of unit.



## No Annual Maintenance

Self-cleaning stainless steel impeller and sealed ball bearing motor make the SS2 virtually maintenance free. Backward inclined impeller blades resist soot build up, reducing vibration and noise problems. Cooling fan forces room air directly over motor to extend its life.



The SS2's innovative design is the result of an extensive research and development program involving heating contractors and end users. Due to its simplicity and practical built-in features, the SS2 takes side wall venting to a higher level of installation and maintenance convenience, operating and energy-saving efficiency — at a very affordable price.

## An Inside Look At The SS2 System

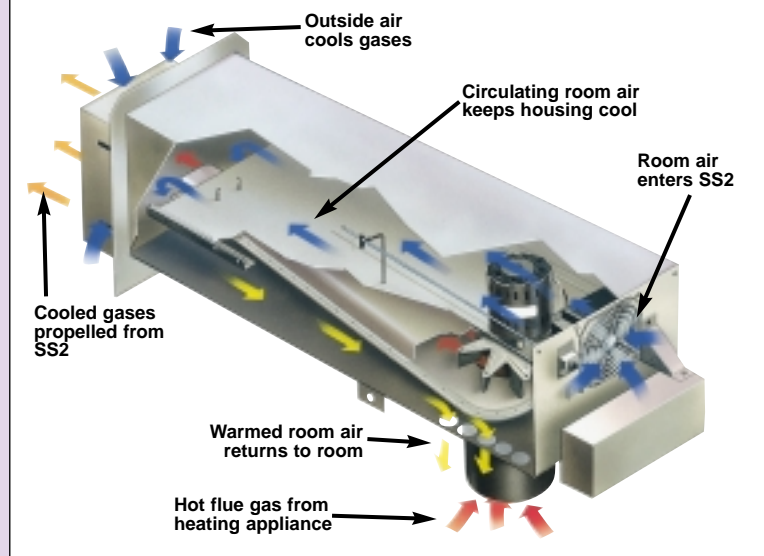



## General Description

The SS2 is a mechanical vent system designed and listed for use with natural draft oil and gas heating equipment. It is factory assembled and wired. The SS2 automatically vents the flue gases from heating equipment to the outdoors. By recirculating indoor air with a cooling fan, surrounding combustible materials remain at safe temperatures. After each burner cycle

the SS2 will continue to operate for an adjustable period to purge the heater and vent of residual flue gases. The SS2 features a 3-way safety system consisting of the UC1 Interlock Control, Fan Proving Switch and High Limit. These devices monitor the SS2 performance and will disrupt the burner if a vent system malfunction is detected.

## SideShot 2 Application Table

Verify that the total BTU/hr. input of the heating appliance(s) falls within the proper category listed below. All BTU/hr. capacity ranges are based on a maximum of 50 equivalent feet. To determine equivalent feet, add the total length of straight vent pipe plus

10 feet for each 90 degree elbow and 5 feet for each 45 degree elbow. Vent runs of over 15 linear feet should use an approved insulated vent connector to prevent problems related to condensation.

NOTE: BTU inputs less than 105,000 may require use of insulated vent pipe for linear runs exceeding 10 feet.



MODEL	Flame Retention Oil Burner	Fan Assisted Natural & LP Gas	Atmospheric Natural & LP Gas	Max. Equivalent Feet
SS2	70,000 - 168,000*	40,000 - 150,000 BTU/hr	40,000 - 125,000 BTU/hr	50

\*Calculate BTU/hr. input based on nozzle size and actual pump pressure. Maximum capacity based on 13% CO<sub>2</sub> and Max. 500°F inlet temperature.

## Dimensions

A	B	C	D	E	F	G	H	I	J
32-1/2"	28-1/2"	5-1/2"	22-3/8"	7-3/4"	8"	12-1/2"	13-1/4"	10-1/2"	8-1/2"

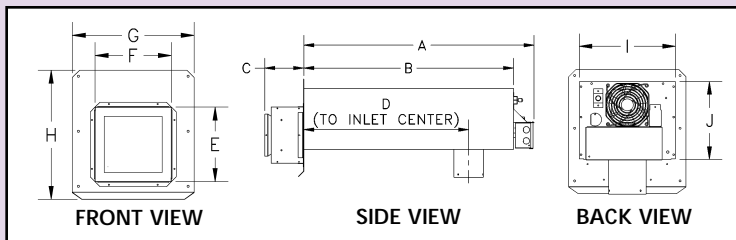

Note: SS2 has a 4" vent connector. Install full size vent pipe and reduce at SS2 connector. The SS2 requires an 8 1/2"H x 10 1/2"W opening through the wall.

## Electrical

Power Requirement: Maximum of 2.3 amps

Motor HP: 1/20

Pre-Purge: Options (0, 5, 20, 35 seconds)

Post-Purge: Factory set at 2 minutes, Options (0, 30 seconds, 1, 2, 4, 8, 16 minutes)

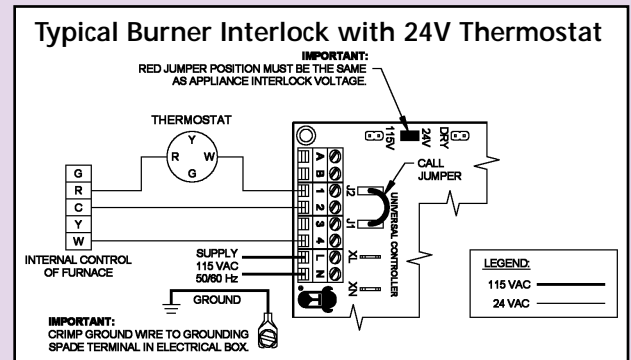

Tjernlund Side Wall Venting Systems are available from:



**TJERNLUND PRODUCTS, INC.**

1601 Ninth Street White Bear Lake, MN 55110-6794

Phone: 651.426.2993 800.255.4208 Fax: 651.426.9547

Visit our web site: [www.tjernlund.com](http://www.tjernlund.com)